

Data sheet | Item number: 209-148

Multi mounting adapter; for male and female connectors with snap-in mounting feet

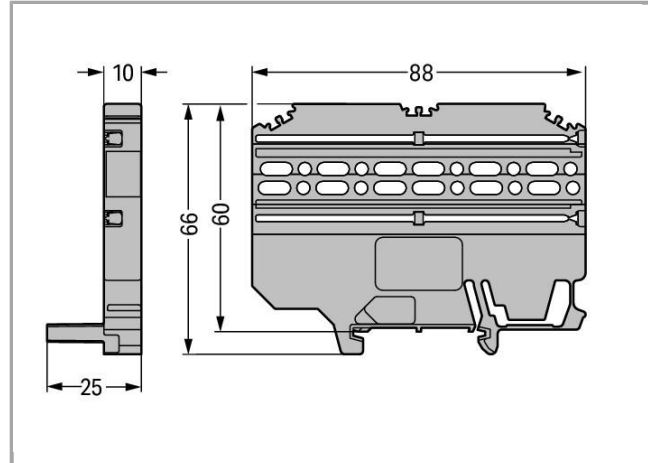

209-148

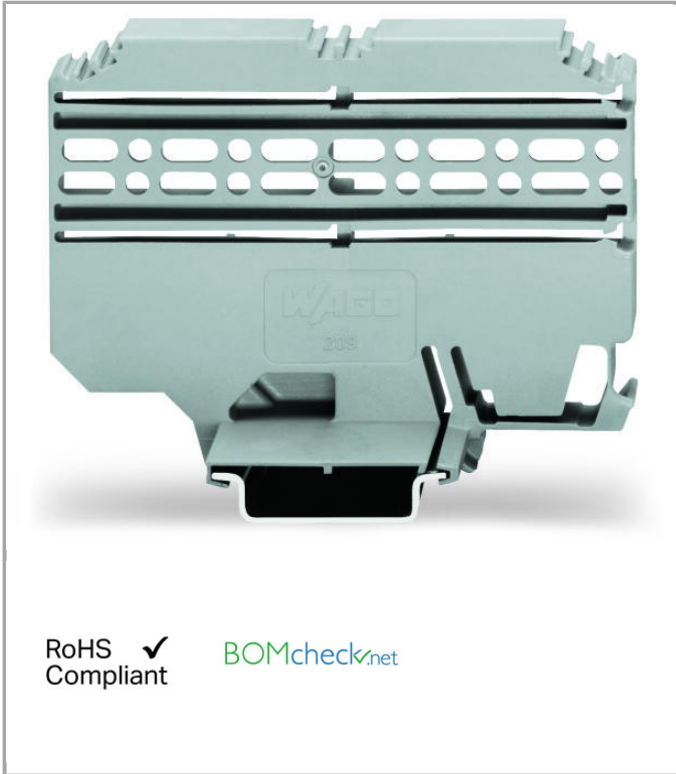

RoHS Compliant [BOMcheck.net](https://www.bomcheck.net)

Data

Connection data

Number of connection types 1

Geometrical Data

Width 25 mm / 0.984 inch
Height 60 mm / 2.362 inch
Depth 88 mm / 3.465 inch

Mechanical data

Mounting type Snap-in mounting foot
Type of mounting DIN-35 rail

Material Data











Fire load 0.458 MJ
Weight 18.24 g















Commercial data















Product Group	2 (Terminal Block Accessories)
Country of origin	PL
GTIN	4017332968829
Customs Tariff No.	39269097900















Compatible products















General accessories















	Item no.: 231-602/018-000 1-conductor male connector; Snap-in mounting feet; 2.5 mm ² ; Pin spacing 5 mm; 2-pole	/U 18-000	231-602
	Item no.: 231-603/018-000 1-conductor male connector; Snap-in mounting feet; 2.5 mm ² ; Pin spacing 5 mm; 3-pole	/U 18-000	231-603
	Item no.: 231-604/018-000 1-conductor male connector; Snap-in mounting feet; 2.5 mm ² ; Pin spacing 5 mm; 4-pole	/U 18-000	231-604
	Item no.: 231-605/018-000 1-conductor male connector; Snap-in mounting feet; 2.5 mm ² ; Pin spacing 5 mm; 5-pole	/U 18-000	231-605
	Item no.: 231-606/018-000 1-conductor male connector; Snap-in mounting feet; 2.5 mm ² ; Pin spacing 5 mm; 6-pole	/U 18-000	231-606
	Item no.: 231-607/018-000 1-conductor male connector; Snap-in mounting feet; 2.5 mm ² ; Pin spacing 5 mm; 7-pole	/U 18-000	231-607
	Item no.: 231-608/018-000 1-conductor male connector; Snap-in mounting feet; 2.5 mm ² ; Pin spacing 5 mm; 8-pole	/U 18-000	231-608
	Item no.: 231-609/018-000 1-conductor male connector; Snap-in mounting feet; 2.5 mm ² ; Pin spacing 5 mm; 9-pole	/U 18-000	231-609
	Item no.: 231-610/018-000 1-conductor male connector; Snap-in mounting feet; 2.5 mm ² ; Pin spacing 5 mm; 10-pole	/U 18-000	231-610
	Item no.: 231-611/018-000 1-conductor male connector; Snap-in mounting feet; 2.5 mm ² ; Pin spacing 5 mm; 11-pole	/U 18-000	231-611
	Item no.: 231-612/018-000 1-conductor male connector; Snap-in mounting feet; 2.5 mm ² ; Pin spacing 5 mm; 12-pole	/U 18-000	231-612

	Item no.: 231-613/018-000 1-conductor male connector; Snap-in mounting feet; 2.5 mm ² ; Pin spacing 5 mm; 13-pole	231-613 /018-000
	Item no.: 231-614/018-000 1-conductor male connector; Snap-in mounting feet; 2.5 mm ² ; Pin spacing 5 mm; 14-pole	231-614 /018-000
	Item no.: 231-615/018-000 1-conductor male connector; Snap-in mounting feet; 2.5 mm ² ; Pin spacing 5 mm; 15-pole	231-615 /018-000
	Item no.: 231-616/018-000 1-conductor male connector; Snap-in mounting feet; 2.5 mm ² ; Pin spacing 5 mm; 16-pole	231-616 /018-000
	Item no.: 231-617/018-000 1-conductor male connector; Snap-in mounting feet; 2.5 mm ² ; Pin spacing 5 mm; 17-pole	231-617 /018-000
	Item no.: 231-632/018-000 1-conductor male connector; Snap-in mounting feet; 2.5 mm ² ; Pin spacing 5.08 mm; 2-pole	231-632 /018-000
	Item no.: 231-633/018-000 1-conductor male connector; Snap-in mounting feet; 2.5 mm ² ; Pin spacing 5.08 mm; 3-pole	231-633 /018-000
	Item no.: 231-634/018-000 1-conductor male connector; Snap-in mounting feet; 2.5 mm ² ; Pin spacing 5.08 mm; 4-pole	231-634 /018-000
	Item no.: 231-635/018-000 1-conductor male connector; Snap-in mounting feet; 2.5 mm ² ; Pin spacing 5.08 mm; 5-pole	231-635 /018-000
	Item no.: 231-636/018-000 1-conductor male connector; Snap-in mounting feet; 2.5 mm ² ; Pin spacing 5.08 mm; 6-pole	231-636 /018-000
	Item no.: 231-637/018-000 1-conductor male connector; Snap-in mounting feet; 2.5 mm ² ; Pin spacing 5.08 mm; 7-pole	231-637 /018-000
	Item no.: 231-638/018-000 1-conductor male connector; Snap-in mounting feet; 2.5 mm ² ; Pin spacing 5.08 mm; 8-pole	231-638 /018-000
	Item no.: 231-639/018-000 1-conductor male connector; Snap-in mounting feet; 2.5 mm ² ; Pin spacing 5.08 mm; 9-pole	231-639 /018-000
	Item no.: 231-640/018-000 1-conductor male connector; Snap-in mounting feet; 2.5 mm ² ; Pin spacing 5.08 mm; 10-pole	231-640 /018-000

	Item no.: 231-641/018-000 1-conductor male connector; Snap-in mounting feet; 2.5 mm ² ; Pin spacing 5.08 mm; 11-pole	231-641 /018-000
	Item no.: 231-642/018-000 1-conductor male connector; Snap-in mounting feet; 2.5 mm ² ; Pin spacing 5.08 mm; 12-pole	231-642 /018-000
	Item no.: 231-643/018-000 1-conductor male connector; Snap-in mounting feet; 2.5 mm ² ; Pin spacing 5.08 mm; 13-pole	231-643 /018-000
	Item no.: 231-644/018-000 1-conductor male connector; Snap-in mounting feet; 2.5 mm ² ; Pin spacing 5.08 mm; 14-pole	231-644 /018-000
	Item no.: 231-645/018-000 1-conductor male connector; Snap-in mounting feet; 2.5 mm ² ; Pin spacing 5.08 mm; 15-pole	231-645 /018-000
	Item no.: 231-646/018-000 1-conductor male connector; Snap-in mounting feet; 2.5 mm ² ; Pin spacing 5.08 mm; 16-pole	231-646 /018-000
Female plug		
	Item no.: 231-102/008-000 1-conductor female plug; Snap-in mounting feet; 2.5 mm ² ; Pin spacing 5 mm; 2-pole	231-102 /008-000
	Item no.: 231-103/008-000 1-conductor female plug; Snap-in mounting feet; 2.5 mm ² ; Pin spacing 5 mm; 3-pole	231-103 /008-000
	Item no.: 231-104/008-000 1-conductor female plug; Snap-in mounting feet; 2.5 mm ² ; Pin spacing 5 mm; 4-pole	231-104 /008-000
	Item no.: 231-105/008-000 1-conductor female plug; Snap-in mounting feet; 2.5 mm ² ; Pin spacing 5 mm; 5-pole	231-105 /008-000
	Item no.: 231-106/008-000 1-conductor female plug; Snap-in mounting feet; 2.5 mm ² ; Pin spacing 5 mm; 6-pole	231-106 /008-000
	Item no.: 231-107/008-000 1-conductor female plug; Snap-in mounting feet; 2.5 mm ² ; Pin spacing 5 mm; 7-pole	231-107 /008-000
	Item no.: 231-108/008-000 1-conductor female plug; Snap-in mounting feet; 2.5 mm ² ; Pin spacing 5 mm; 8-pole	231-108 /008-000
	Item no.: 231-109/008-000 1-conductor female plug; Snap-in mounting feet; 2.5 mm ² ; Pin spacing 5 mm; 9-pole	231-109 /008-000















	Item no.: 231-110/008-000 1-conductor female plug; Snap-in mounting feet; 2.5 mm ² ; Pin spacing 5 mm; 10-pole	/008-000	231-110
	Item no.: 231-111/008-000 1-conductor female plug; Snap-in mounting feet; 2.5 mm ² ; Pin spacing 5 mm; 11-pole	/008-000	231-111
	Item no.: 231-112/008-000 1-conductor female plug; Snap-in mounting feet; 2.5 mm ² ; Pin spacing 5 mm; 12-pole	/008-000	231-112
	Item no.: 231-113/008-000 1-conductor female plug; Snap-in mounting feet; 2.5 mm ² ; Pin spacing 5 mm; 13-pole	/008-000	231-113
	Item no.: 231-114/008-000 1-conductor female plug; Snap-in mounting feet; 2.5 mm ² ; Pin spacing 5 mm; 14-pole	/008-000	231-114
	Item no.: 231-115/008-000 1-conductor female plug; Snap-in mounting feet; 2.5 mm ² ; Pin spacing 5 mm; 15-pole	/008-000	231-115
	Item no.: 231-116/008-000 1-conductor female plug; Snap-in mounting feet; 2.5 mm ² ; Pin spacing 5 mm; 16-pole	/008-000	231-116
	Item no.: 231-117/008-000 1-conductor female plug; Snap-in mounting feet; 2.5 mm ² ; Pin spacing 5 mm; 17-pole	/008-000	231-117
	Item no.: 231-118/008-000 1-conductor female plug; Snap-in mounting feet; 2.5 mm ² ; Pin spacing 5 mm; 18-pole	/008-000	231-118
	Item no.: 231-119/008-000 1-conductor female plug; Snap-in mounting feet; 2.5 mm ² ; Pin spacing 5 mm; 19-pole	/008-000	231-119
	Item no.: 231-120/008-000 1-conductor female plug; Snap-in mounting feet; 2.5 mm ² ; Pin spacing 5 mm; 20-pole	/008-000	231-120
	Item no.: 231-121/008-000 1-conductor female plug; Snap-in mounting feet; 2.5 mm ² ; Pin spacing 5 mm; 21-pole	/008-000	231-121
	Item no.: 231-122/008-000 1-conductor female plug; Snap-in mounting feet; 2.5 mm ² ; Pin spacing 5 mm; 22-pole	/008-000	231-122
	Item no.: 231-123/008-000 1-conductor female plug; Snap-in mounting feet; 2.5 mm ² ; Pin spacing 5 mm; 23-pole	/008-000	231-123
	Item no.: 231-124/008-000 1-conductor female plug; Snap-in mounting feet; 2.5 mm ² ; Pin spacing 5 mm; 24-pole	/008-000	231-124

	Item no.: 231-202/008-000 1-conductor female plug; Snap-in mounting feet; 2.5 mm ² ; Pin spacing 7.5 mm; 2-pole	/008-000	231-202
	Item no.: 231-203/008-000 1-conductor female plug; Snap-in mounting feet; 2.5 mm ² ; Pin spacing 7.5 mm; 3-pole	/008-000	231-203
	Item no.: 231-204/008-000 1-conductor female plug; Snap-in mounting feet; 2.5 mm ² ; Pin spacing 7.5 mm; 4-pole	/008-000	231-204
	Item no.: 231-205/008-000 1-conductor female plug; Snap-in mounting feet; 2.5 mm ² ; Pin spacing 7.5 mm; 5-pole	/008-000	231-205
	Item no.: 231-206/008-000 1-conductor female plug; Snap-in mounting feet; 2.5 mm ² ; Pin spacing 7.5 mm; 6-pole	/008-000	231-206
	Item no.: 231-207/008-000 1-conductor female plug; Snap-in mounting feet; 2.5 mm ² ; Pin spacing 7.5 mm; 7-pole	/008-000	231-207
	Item no.: 231-208/008-000 1-conductor female plug; Snap-in mounting feet; 2.5 mm ² ; Pin spacing 7.5 mm; 8-pole	/008-000	231-208
	Item no.: 231-209/008-000 1-conductor female plug; Snap-in mounting feet; 2.5 mm ² ; Pin spacing 7.5 mm; 9-pole	/008-000	231-209
	Item no.: 231-210/008-000 1-conductor female plug; Snap-in mounting feet; 2.5 mm ² ; Pin spacing 7.5 mm; 10-pole	/008-000	231-210
	Item no.: 231-211/008-000 1-conductor female plug; Snap-in mounting feet; 2.5 mm ² ; Pin spacing 7.5 mm; 11-pole	/008-000	231-211
	Item no.: 231-212/008-000 1-conductor female plug; Snap-in mounting feet; 2.5 mm ² ; Pin spacing 7.5 mm; 12-pole	/008-000	231-212
	Item no.: 231-213/008-000 1-conductor female plug; Snap-in mounting feet; 2.5 mm ² ; Pin spacing 7.5 mm; 13-pole	/008-000	231-213
	Item no.: 231-216/008-000 1-conductor female plug; Snap-in mounting feet; 2.5 mm ² ; Pin spacing 7.5 mm; 16-pole	/008-000	231-216
	Item no.: 231-302/008-000 1-conductor female plug; Snap-in mounting feet; 2.5 mm ² ; Pin spacing 5.08 mm; 2-pole	/008-000	231-302















	Item no.: 231-303/008-000 1-conductor female plug; Snap-in mounting feet; 2.5 mm ² ; Pin spacing 5.08 mm; 3-pole	231-303 /008-000
	Item no.: 231-304/008-000 1-conductor female plug; Snap-in mounting feet; 2.5 mm ² ; Pin spacing 5.08 mm; 4-pole	231-304 /008-000
	Item no.: 231-305/008-000 1-conductor female plug; Snap-in mounting feet; 2.5 mm ² ; Pin spacing 5.08 mm; 5-pole	231-305 /008-000
	Item no.: 231-306/008-000 1-conductor female plug; Snap-in mounting feet; 2.5 mm ² ; Pin spacing 5.08 mm; 6-pole	231-306 /008-000
	Item no.: 231-307/008-000 1-conductor female plug; Snap-in mounting feet; 2.5 mm ² ; Pin spacing 5.08 mm; 7-pole	231-307 /008-000
	Item no.: 231-308/008-000 1-conductor female plug; Snap-in mounting feet; 2.5 mm ² ; Pin spacing 5.08 mm; 8-pole	231-308 /008-000
	Item no.: 231-309/008-000 1-conductor female plug; Snap-in mounting feet; 2.5 mm ² ; Pin spacing 5.08 mm; 9-pole	231-309 /008-000
	Item no.: 231-310/008-000 1-conductor female plug; Snap-in mounting feet; 2.5 mm ² ; Pin spacing 5.08 mm; 10-pole	231-310 /008-000
	Item no.: 231-311/008-000 1-conductor female plug; Snap-in mounting feet; 2.5 mm ² ; Pin spacing 5.08 mm; 11-pole	231-311 /008-000
	Item no.: 231-312/008-000 1-conductor female plug; Snap-in mounting feet; 2.5 mm ² ; Pin spacing 5.08 mm; 12-pole	231-312 /008-000
	Item no.: 231-313/008-000 1-conductor female plug; Snap-in mounting feet; 2.5 mm ² ; Pin spacing 5.08 mm; 13-pole	231-313 /008-000
	Item no.: 231-314/008-000 1-conductor female plug; Snap-in mounting feet; 2.5 mm ² ; Pin spacing 5.08 mm; 14-pole	231-314 /008-000
	Item no.: 231-315/008-000 1-conductor female plug; Snap-in mounting feet; 2.5 mm ² ; Pin spacing 5.08 mm; 15-pole	231-315 /008-000
	Item no.: 231-316/008-000 1-conductor female plug; Snap-in mounting feet; 2.5 mm ² ; Pin spacing 5.08 mm; 16-pole	231-316 /008-000
	Item no.: 231-317/008-000 1-conductor female plug; Snap-in mounting feet; 2.5 mm ² ; Pin spacing 5.08 mm; 17-pole	231-317 /008-000

















Item no.: 231-318/008-000 1-conductor female plug; Snap-in mounting feet; 2.5 mm ² ; Pin spacing 5.08 mm; 18-pole	/008-000	231-318
Item no.: 231-319/008-000 1-conductor female plug; Snap-in mounting feet; 2.5 mm ² ; Pin spacing 5.08 mm; 19-pole	/008-000	231-319
Item no.: 231-320/008-000 1-conductor female plug; Snap-in mounting feet; 2.5 mm ² ; Pin spacing 5.08 mm; 20-pole	/008-000	231-320
Item no.: 231-321/008-000 1-conductor female plug; Snap-in mounting feet; 2.5 mm ² ; Pin spacing 5.08 mm; 21-pole	/008-000	231-321
Item no.: 231-322/008-000 1-conductor female plug; Snap-in mounting feet; 2.5 mm ² ; Pin spacing 5.08 mm; 22-pole	/008-000	231-322
Item no.: 231-323/008-000 1-conductor female plug; Snap-in mounting feet; 2.5 mm ² ; Pin spacing 5.08 mm; 23-pole	/008-000	231-323
Item no.: 231-324/008-000 1-conductor female plug; Snap-in mounting feet; 2.5 mm ² ; Pin spacing 5.08 mm; 24-pole	/008-000	231-324
Item no.: 231-702/008-000 1-conductor female plug; Snap-in mounting feet; 2.5 mm ² ; Pin spacing 7.62 mm; 2-pole	/008-000	231-702
Item no.: 231-703/008-000 1-conductor female plug; Snap-in mounting feet; 2.5 mm ² ; Pin spacing 7.62 mm; 3-pole	/008-000	231-703
Item no.: 231-704/008-000 1-conductor female plug; Snap-in mounting feet; 2.5 mm ² ; Pin spacing 7.62 mm; 4-pole	/008-000	231-704
Item no.: 231-705/008-000 1-conductor female plug; Snap-in mounting feet; 2.5 mm ² ; Pin spacing 7.62 mm; 5-pole	/008-000	231-705
Item no.: 231-706/008-000 1-conductor female plug; Snap-in mounting feet; 2.5 mm ² ; Pin spacing 7.62 mm; 6-pole	/008-000	231-706
Item no.: 231-707/008-000 1-conductor female plug; Snap-in mounting feet; 2.5 mm ² ; Pin spacing 7.62 mm; 7-pole	/008-000	231-707
Item no.: 231-708/008-000 1-conductor female plug; Snap-in mounting feet; 2.5 mm ² ; Pin spacing 7.62 mm; 8-pole	/008-000	231-708















	Item no.: 231-709/008-000 1-conductor female plug; Snap-in mounting feet; 2.5 mm ² ; Pin spacing 7.62 mm; 9-pole	/008-000	231-709
	Item no.: 231-710/008-000 1-conductor female plug; Snap-in mounting feet; 2.5 mm ² ; Pin spacing 7.62 mm; 10-pole	/008-000	231-710
	Item no.: 231-711/008-000 1-conductor female plug; Snap-in mounting feet; 2.5 mm ² ; Pin spacing 7.62 mm; 11-pole	/008-000	231-711
	Item no.: 231-712/008-000 1-conductor female plug; Snap-in mounting feet; 2.5 mm ² ; Pin spacing 7.62 mm; 12-pole	/008-000	231-712
	Item no.: 721-102/008-000 1-conductor female plug; 100% protected against mismatching; Snap-in mounting feet; 2.5 mm ² ; Pin spacing 5 mm; 2-pole	/008-000	721-102
	Item no.: 721-103/008-000 1-conductor female plug; 100% protected against mismatching; Snap-in mounting feet; 2.5 mm ² ; Pin spacing 5 mm; 3-pole	/008-000	721-103
	Item no.: 721-104/008-000 1-conductor female plug; 100% protected against mismatching; Snap-in mounting feet; 2.5 mm ² ; Pin spacing 5 mm; 4-pole	/008-000	721-104
	Item no.: 721-105/008-000 1-conductor female plug; 100% protected against mismatching; Snap-in mounting feet; 2.5 mm ² ; Pin spacing 5 mm; 5-pole	/008-000	721-105
	Item no.: 721-106/008-000 1-conductor female plug; 100% protected against mismatching; Snap-in mounting feet; 2.5 mm ² ; Pin spacing 5 mm; 6-pole	/008-000	721-106
	Item no.: 721-107/008-000 1-conductor female plug; 100% protected against mismatching; Snap-in mounting feet; 2.5 mm ² ; Pin spacing 5 mm; 7-pole	/008-000	721-107
	Item no.: 721-108/008-000 1-conductor female plug; 100% protected against mismatching; Snap-in mounting feet; 2.5 mm ² ; Pin spacing 5 mm; 8-pole	/008-000	721-108
	Item no.: 721-109/008-000 1-conductor female plug; 100% protected against mismatching; Snap-in mounting feet; 2.5 mm ² ; Pin spacing 5 mm; 9-pole	/008-000	721-109
	Item no.: 721-110/008-000 1-conductor female plug; 100% protected against mismatching; Snap-in mounting feet; 2.5 mm ² ; Pin spacing 5 mm; 10-pole	/008-000	721-110
	Item no.: 721-112/008-000 1-conductor female plug; 100% protected against mismatching; Snap-in mounting feet; 2.5 mm ² ; Pin spacing 5 mm; 12-pole	/008-000	721-112
	Item no.: 721-114/008-000 1-conductor female plug; 100% protected against mismatching; Snap-in mounting feet; 2.5 mm ² ; Pin	/008-000	721-114











spacing 5 mm; 14-pole

	Item no.: 721-116/008-000 1-conductor female plug; 100% protected against mismatching; Snap-in mounting feet; 2.5 mm ² ; Pin spacing 5 mm; 16-pole	/008-000	721-116
	Item no.: 721-120/008-000 1-conductor female plug; 100% protected against mismatching; Snap-in mounting feet; 2.5 mm ² ; Pin spacing 5 mm; 20-pole	/008-000	721-120
	Item no.: 721-202/008-000 1-conductor female plug; 100% protected against mismatching; Snap-in mounting feet; 2.5 mm ² ; Pin spacing 7.5 mm; 2-pole	/008-000	721-202
	Item no.: 721-203/008-000 1-conductor female plug; 100% protected against mismatching; Snap-in mounting feet; 2.5 mm ² ; Pin spacing 7.5 mm; 3-pole	/008-000	721-203
	Item no.: 721-204/008-000 1-conductor female plug; 100% protected against mismatching; Snap-in mounting feet; 2.5 mm ² ; Pin spacing 7.5 mm; 4-pole	/008-000	721-204
	Item no.: 721-205/008-000 1-conductor female plug; 100% protected against mismatching; Snap-in mounting feet; 2.5 mm ² ; Pin spacing 7.5 mm; 5-pole	/008-000	721-205
	Item no.: 721-206/008-000 1-conductor female plug; 100% protected against mismatching; Snap-in mounting feet; 2.5 mm ² ; Pin spacing 7.5 mm; 6-pole	/008-000	721-206
	Item no.: 721-207/008-000 1-conductor female plug; 100% protected against mismatching; Snap-in mounting feet; 2.5 mm ² ; Pin spacing 7.5 mm; 7-pole	/008-000	721-207
	Item no.: 721-208/008-000 1-conductor female plug; 100% protected against mismatching; Snap-in mounting feet; 2.5 mm ² ; Pin spacing 7.5 mm; 8-pole	/008-000	721-208
	Item no.: 721-209/008-000 1-conductor female plug; 100% protected against mismatching; Snap-in mounting feet; 2.5 mm ² ; Pin spacing 7.5 mm; 9-pole	/008-000	721-209
	Item no.: 721-210/008-000 1-conductor female plug; 100% protected against mismatching; Snap-in mounting feet; 2.5 mm ² ; Pin spacing 7.5 mm; 10-pole	/008-000	721-210
	Item no.: 721-211/008-000 1-conductor female plug; 100% protected against mismatching; Snap-in mounting feet; 2.5 mm ² ; Pin spacing 7.5 mm; 11-pole	/008-000	721-211
	Item no.: 721-212/008-000 1-conductor female plug; 100% protected against mismatching; Snap-in mounting feet; 2.5 mm ² ; Pin spacing 7.5 mm; 12-pole	/008-000	721-212
	Item no.: 721-302/008-000 1-conductor female plug; angled; 100% protected against mismatching; Snap-in mounting feet; 2.5 mm ² ; Pin spacing 5 mm; 2-pole	/008-000	721-302

Item no.: 721-303/008-000

	1-conductor female plug; angled; 100% protected against mismatching; Snap-in mounting feet; 2.5 mm ² ; Pin spacing 5 mm; 3-pole	721-303 /008-000
	Item no.: 721-304/008-000 1-conductor female plug; angled; 100% protected against mismatching; Snap-in mounting feet; 2.5 mm ² ; Pin spacing 5 mm; 4-pole	721-304 /008-000
	Item no.: 721-305/008-000 1-conductor female plug; angled; 100% protected against mismatching; Snap-in mounting feet; 2.5 mm ² ; Pin spacing 5 mm; 5-pole	721-305 /008-000
	Item no.: 721-306/008-000 1-conductor female plug; angled; 100% protected against mismatching; Snap-in mounting feet; 2.5 mm ² ; Pin spacing 5 mm; 6-pole	721-306 /008-000
	Item no.: 721-307/008-000 1-conductor female plug; angled; 100% protected against mismatching; Snap-in mounting feet; 2.5 mm ² ; Pin spacing 5 mm; 7-pole	721-307 /008-000
	Item no.: 721-308/008-000 1-conductor female plug; angled; 100% protected against mismatching; Snap-in mounting feet; 2.5 mm ² ; Pin spacing 5 mm; 8-pole	721-308 /008-000
	Item no.: 721-309/008-000 1-conductor female plug; angled; 100% protected against mismatching; Snap-in mounting feet; 2.5 mm ² ; Pin spacing 5 mm; 9-pole	721-309 /008-000
	Item no.: 721-310/008-000 1-conductor female plug; angled; 100% protected against mismatching; Snap-in mounting feet; 2.5 mm ² ; Pin spacing 5 mm; 10-pole	721-310 /008-000
	Item no.: 721-312/008-000 1-conductor female plug; angled; 100% protected against mismatching; Snap-in mounting feet; 2.5 mm ² ; Pin spacing 5 mm; 12-pole	721-312 /008-000
	Item no.: 721-314/008-000 1-conductor female plug; angled; 100% protected against mismatching; Snap-in mounting feet; 2.5 mm ² ; Pin spacing 5 mm; 14-pole	721-314 /008-000
	Item no.: 721-316/008-000 1-conductor female plug; angled; 100% protected against mismatching; Snap-in mounting feet; 2.5 mm ² ; Pin spacing 5 mm; 16-pole	721-316 /008-000
	Item no.: 721-320/008-000 1-conductor female plug; angled; 100% protected against mismatching; Snap-in mounting feet; 2.5 mm ² ; Pin spacing 5 mm; 20-pole	721-320 /008-000
	Item no.: 731-502/008-000 1-conductor female plug; angled; Snap-in mounting feet; 2.5 mm ² ; Pin spacing 5 mm; 2-pole	731-502 /008-000
	Item no.: 731-504/008-000 1-conductor female plug; angled; Snap-in mounting feet; 2.5 mm ² ; Pin spacing 5 mm; 4-pole	731-504 /008-000
	Item no.: 731-505/008-000 1-conductor female plug; angled; Snap-in mounting feet; 2.5 mm ² ; Pin spacing 5 mm; 5-pole	731-505 /008-000

	Item no.: 731-506/008-000 1-conductor female plug; angled; Snap-in mounting feet; 2.5 mm ² ; Pin spacing 5 mm; 6-pole	731-506
	Item no.: 731-507/008-000 1-conductor female plug; angled; Snap-in mounting feet; 2.5 mm ² ; Pin spacing 5 mm; 7-pole	731-507
	Item no.: 731-508/008-000 1-conductor female plug; angled; Snap-in mounting feet; 2.5 mm ² ; Pin spacing 5 mm; 8-pole	731-508
	Item no.: 731-510/008-000 1-conductor female plug; angled; Snap-in mounting feet; 2.5 mm ² ; Pin spacing 5 mm; 10-pole	731-510
	Item no.: 731-512/008-000 1-conductor female plug; angled; Snap-in mounting feet; 2.5 mm ² ; Pin spacing 5 mm; 12-pole	731-512
	Item no.: 731-513/008-000 1-conductor female plug; angled; Snap-in mounting feet; 2.5 mm ² ; Pin spacing 5 mm; 13-pole	731-513
	Item no.: 731-517/008-000 1-conductor female plug; angled; Snap-in mounting feet; 2.5 mm ² ; Pin spacing 5 mm; 17-pole	731-517
	Item no.: 731-518/008-000 1-conductor female plug; angled; Snap-in mounting feet; 2.5 mm ² ; Pin spacing 5 mm; 18-pole	731-518
	Item no.: 731-519/008-000 1-conductor female plug; angled; Snap-in mounting feet; 2.5 mm ² ; Pin spacing 5 mm; 19-pole	731-519
	Item no.: 731-520/008-000 1-conductor female plug; angled; Snap-in mounting feet; 2.5 mm ² ; Pin spacing 5 mm; 20-pole	731-520
	Item no.: 731-532/008-000 1-conductor female plug; angled; Snap-in mounting feet; 2.5 mm ² ; Pin spacing 7.5 mm; 2-pole	731-532
	Item no.: 731-533/008-000 1-conductor female plug; angled; Snap-in mounting feet; 2.5 mm ² ; Pin spacing 7.5 mm; 3-pole	731-533
	Item no.: 731-534/008-000 1-conductor female plug; angled; Snap-in mounting feet; 2.5 mm ² ; Pin spacing 7.5 mm; 4-pole	731-534
	Item no.: 731-535/008-000 1-conductor female plug; angled; Snap-in mounting feet; 2.5 mm ² ; Pin spacing 7.5 mm; 5-pole	731-535

	Item no.: 731-536/008-000 1-conductor female plug; angled; Snap-in mounting feet; 2.5 mm ² ; Pin spacing 7.5 mm; 6-pole	731-536 /008-000
	Item no.: 731-537/008-000 1-conductor female plug; angled; Snap-in mounting feet; 2.5 mm ² ; Pin spacing 7.5 mm; 7-pole	731-537 /008-000
	Item no.: 731-538/008-000 1-conductor female plug; angled; Snap-in mounting feet; 2.5 mm ² ; Pin spacing 7.5 mm; 8-pole	731-538 /008-000
	Item no.: 731-539/008-000 1-conductor female plug; angled; Snap-in mounting feet; 2.5 mm ² ; Pin spacing 7.5 mm; 9-pole	731-539 /008-000
	Item no.: 731-540/008-000 1-conductor female plug; angled; Snap-in mounting feet; 2.5 mm ² ; Pin spacing 7.5 mm; 10-pole	731-540 /008-000
	Item no.: 731-541/008-000 1-conductor female plug; angled; Snap-in mounting feet; 2.5 mm ² ; Pin spacing 7.5 mm; 11-pole	731-541 /008-000
	Item no.: 731-542/008-000 1-conductor female plug; angled; Snap-in mounting feet; 2.5 mm ² ; Pin spacing 7.5 mm; 12-pole	731-542 /008-000
	Item no.: 731-543/008-000 1-conductor female plug; angled; Snap-in mounting feet; 2.5 mm ² ; Pin spacing 7.5 mm; 13-pole	731-543 /008-000
	Item no.: 731-546/008-000 1-conductor female plug; angled; Snap-in mounting feet; 2.5 mm ² ; Pin spacing 7.5 mm; 16-pole	731-546 /008-000
shield connection		
	Item no.: 790-108 Shield clamping saddle; 11 mm wide; diameter of compatible conductor	790-108

Downloads

CAD/CAE - Smart Data

CAD data

3D Download 209-148	URL	Download

Subject to changes.